

TO.ME.S. SPECIALS

SINCE 1977 Made in Italy ISO 9001:2008



Elettropompe a palette autoadescanti con motore asincrono a corrente alternata. Corpo pompante costruito con materiali di qualità, leggeri, resistenti ai liquidi per impianti fotovoltaici.



Self-priming vanes Electric pumps, powered by asynchronous AC motor. Body pump constructed with quality materials, lightweight, resistant to liquids for photovoltaic systems.

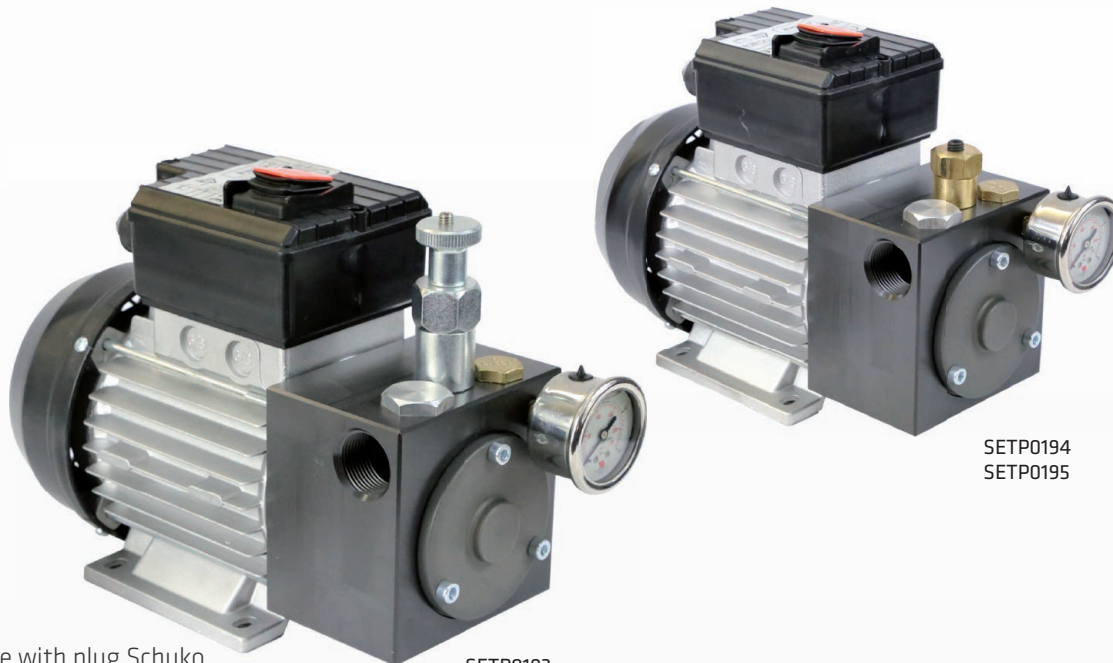

1,5 m cable with plug Schuko

SETP0193
SETP0141

SETP0194
SETP0195

ALUMINIUM



BY-PASS ADJUSTABLE



ANTI-FLOODING

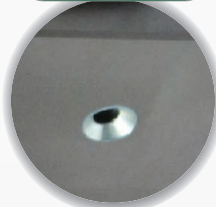

FREE MAX
36
LT/MIN

MANOMETER

1 bar pres
33
LT/MIN

THERMAL PROTECTOR
AUTO-RESET

DIMENSION

(mm)

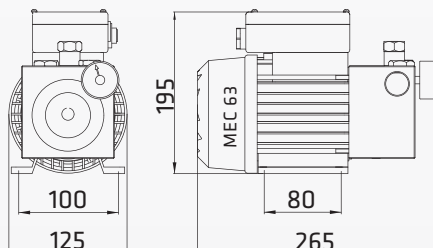

SUCTION

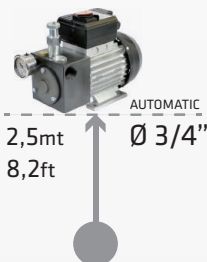

PERFORMANCE

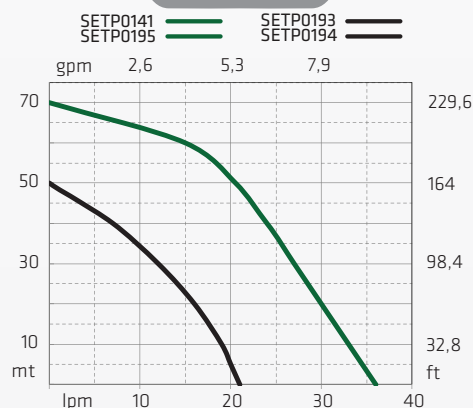

name	flow rate		bar	volts	hp	watt	ampère max	RPM	IN	OUT	weight		packing		code
	LPM	GPM									kg	lbs	cm	inch	
EUROSUN 20	19	5	5	230 50Hz	0,5	373	2,5	2800	3/4" F BSP	3/4" F BSP	6,8	15	34 x 18 x 26	13,4 x 7,1 x 10,2	SETP0193
	19	5	5*	230 50Hz	0,5	373	2,5	2800	3/4" F BSP	3/4" F BSP	6,8	15	34 x 18 x 26	13,4 x 7,1 x 10,2	SETP0194
EUROSUN 35	33	8,7	7	230 50Hz	0,75	560	4	2800	3/4" F BSP	3/4" F BSP	7,4	16,3	34 x 18 x 26	13,4 x 7,1 x 10,2	SETP0141
	33	8,7	7*	230 50Hz	0,75	560	4	2800	3/4" F BSP	3/4" F BSP	7,4	16,3	34 x 18 x 26	13,4 x 7,1 x 10,2	SETP0195



TO.ME.S. SPECIALS

SINCE 1977 Made in Italy ISO 9001:2008



Avvolgitubo automatico per liquidi generici resistente alla corrosione ed alle intemperie. Solido, costruito interamente in inox, con perdite di carico ridotte al minimo. Possibilità di arresto svolgimento del tubo ad ogni giro.



Generic fluid Automatic Hose Reel, weatherproof, corrosion resistant. Solid, compact, made in stainless steel, minimum pressure loss. Hose-Stop at any turn possible.



UAVT0012
SAVT0675

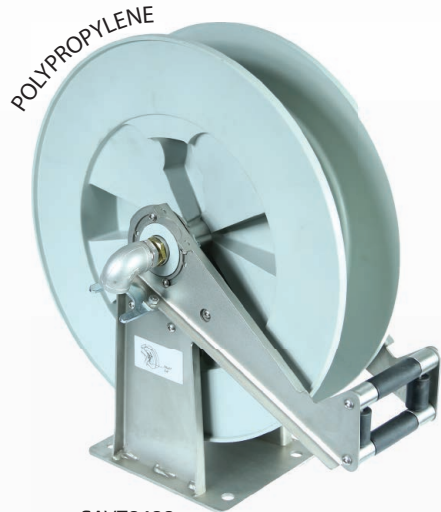

SAVT0400

STAINLESS STEEL



MULTI POSITION

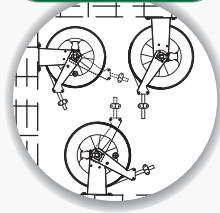

- UP TO
20
mt
- DEVICE
HOSE
GUIDE
- AUTOMATIC
RETURN
HOSE
- DEVICE
HOSE
BUMPER
- DEVICE
HOSE
STOP

DIMENSION
(mm)

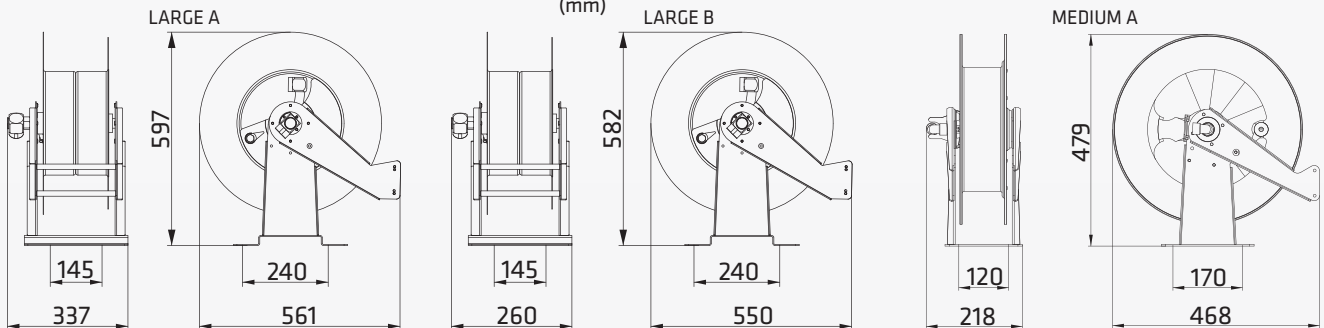

name	hose including	mt		ft		hose max	bar max	IN	OUT	weight		packing		code
										kg	lbs	cm	inch	
LARGE A	NO			19x29	20	65,6	80	1" F BSP	1" F BSP	27,5	60,6	61 x 39 x 65	24 x 15,4 x 25,6	UAVT0012
LARGE B	1/2"	20	65,6				200	1/2" F BSP	1/2" F BSP	37,5	73,9	61 x 35 x 61	24 x 13,8 x 24	SAVT0675
MEDIUM A	NO			3/8"	15	49,2	200	3/8" F BSP	3/8" F BSP	19,0	41,9	46 x 55 x 24	18,1 x 21,7 x 9,4	SAVT0400

TO.ME.S. SPECIALS

SINCE 1977 Made in Italy ISO 9001:2008



Parti di ricambio per riparare o per comporre il kit di erogazione.

Spare parts to repair or to compose your kit delivery.

for hose reel
LARGE



HSTF0442

for hose reel
MEDIUM A



HSTF0634

ORIENTABLE 80°



STAINLESS STEEL



RHSP0012

name	connection	code
REVOLVIG BRACKET		HSTF0442
		HSTF0634
HOSE STOP	1/4" - 3/8" - 1/2"	RHSP0012

TO.ME.S. AIRWATER

SINCE 1977 Made in Italy ISO 9001:2008



Avvolgitubo automatico per aria ed acqua resistente alle intemperie. Solido, compatto, con perdite di carico ridotte al minimo. Possibilità di arresto svolgimento del tubo ad ogni giro.

Air and water Automatic Hose Reel, weatherproof. Solid, compact, minimum pressure loss. Hose-Stop at any turn possible.

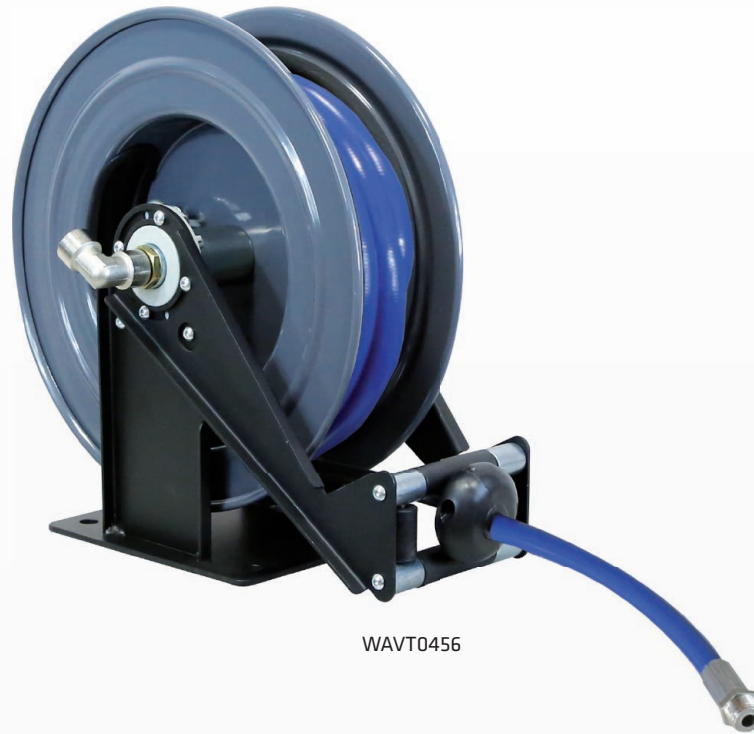

WAVT0456

PAINTED STEEL

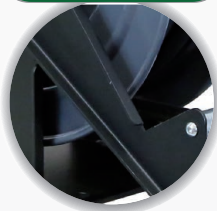

MULTI POSITION

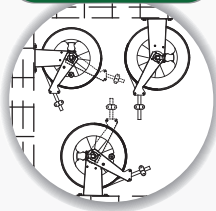

UP TO
10
mt

HOSE
PU 10x14,5
20 bar

AUTOMATIC
RETURN
HOSE

DEVICE
HOSE
GUIDE

DEVICE
HOSE
BUMPER

DEVICE
HOSE
STOP

DIMENSION

(mm)

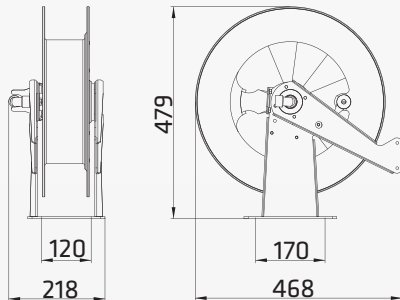

REVOLVING BRACKET

80°



HSTF0441

name	hose including		hose max		bar max	IN	OUT	weight		packing		code	
	mt	ft	mt	ft				kg	lbs	cm	inch		
SMALL	NO		3/8"	10	32,8	80	3/8" F BSP	3/8" M BSP	12	26,5	46 x 46 x 27	18,1 x 18,1 x 10,6	WAVT0010
	10x14,5	10	32,8			20	3/8" F BSP	3/8" M BSP	15,5	34,2	46 x 46 x 27	18,1 x 18,1 x 10,6	WAVT0456

TO.ME.S. AIRWATER

SINCE 1977 Made in Italy ISO 9001:2008



Avvolgitubo automatico per aria ed acqua resistente alle intemperie. Solido, compatto, con perdite di carico ridotte al minimo. Possibilità di arresto svolgimento del tubo ad ogni giro.



Air and water Automatic Hose Reel, weatherproof. Solid, compact, minimum pressure loss. Hose-Stop at any turn possible.



POLYPROPYLENE



PAINTED STEEL

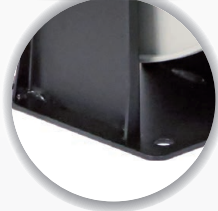

MULTI POSITION

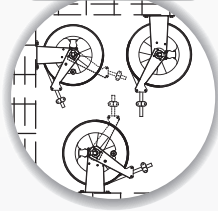

UP TO
15
mt

HOSE
PU 10x14.5
20 bar

AUTOMATIC
RETURN
HOSE

DEVICE
HOSE
GUIDE

DEVICE
HOSE
BUMPER

DEVICE
HOSE
STOP

DIMENSION
(mm)

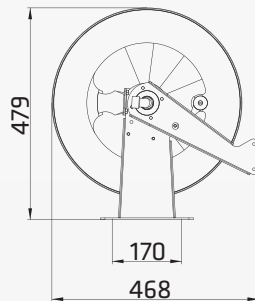
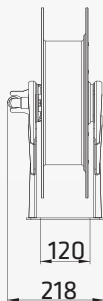

REVOLVING BRACKET

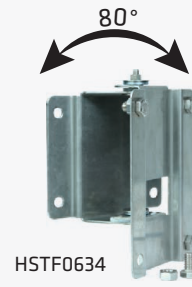
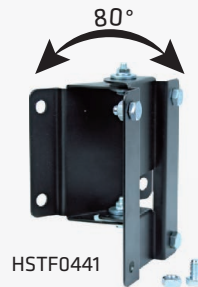

name	hose including		hose max		bar max	IN	OUT	weight		packing		code	
	mt	ft	mt	ft				kg	lbs	cm	inch		
MEDIUM A	NO		3/8"	15	49,2	80	3/8" F BSP	3/8" M BSP	19	41,9	46 x 55 x 24	18,1 x 21,7 x 9,4	WAVT0012
	10x14,5	10	32,8			20	3/8" F BSP	3/8" M BSP	23	50,7	46 x 55 x 24	18,1 x 21,7 x 9,4	WAVT0392
	10x14,5	15	49,2			20	3/8" F BSP	3/8" M BSP	24	52,9	46 x 55 x 24	18,1 x 21,7 x 9,4	WAVT0393
	NO		3/8"	15	49,2	200	3/8" F BSP	3/8" M BSP	19	41,9	46 x 55 x 24	18,1 x 21,7 x 9,4	SAVT0400

TO.ME.S. AIRWATER

SINCE 1977 Made in Italy ISO 9001:2008



Avvolgitubo automatico per aria ed acqua resistente alle intemperie. Solido, compatto, con perdite di carico ridotte al minimo. Possibilità di arresto svolgimento del tubo ad ogni giro.

Air and water Automatic Hose Reel, weatherproof. Solid, compact, minimum pressure loss. Hose-Stop at any turn possible.



WAVT0390
WAVT0391

REVOLVING BRACKET



POLYPROPYLENE



PAINTED STEEL



MULTI POSITION

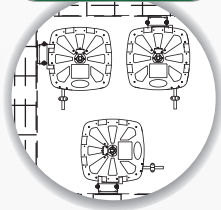

UP TO
15
mt

HOSE
PU 10x14,5
20
bar



AUTOMATIC
RETURN
HOSE

DEVICE
HOSE
GUIDE

DEVICE
HOSE
BUMPER

DEVICE
HOSE
STOP

DIMENSION
(mm)

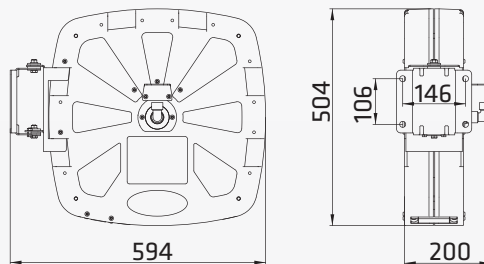

name	hose including		hose max	bar max		IN	OUT	weight		packing		code	
	mt	ft		mt	ft			kg	lbs	cm	inch		
MEDIUM C	NO		3/8"	15	49,2	80	3/8" F BSP	3/8" M BSP	20,5	45,2	54 x 61 x 24	21,3 x 24 x 9,4	WAVT0389
	10x14,5	10	32,8			20	3/8" F BSP	3/8" M BSP	24	52,9	54 x 61 x 24	21,3 x 24 x 9,4	WAVT0390
	10x14,5	15	49,2			20	3/8" F BSP	3/8" M BSP	24,5	54	54 x 61 x 24	21,3 x 24 x 9,4	WAVT0391

TO.ME.S. AIRWATER

SINCE 1977 Made in Italy ISO 9001:2008



Avvolgitubo automatico per aria e acqua resistente alla corrosione ed alle intemperie. Solido, costruito interamente in inox, con perdite di carico ridotte al minimo. Possibilità di arresto svolgimento del tubo ad ogni giro.



Air and water Automatic Hose Reel, weatherproof, corrosion resistant. Solid, compact, made in stainless steel, minimum pressure loss. Hose-Stop at any turn possible.

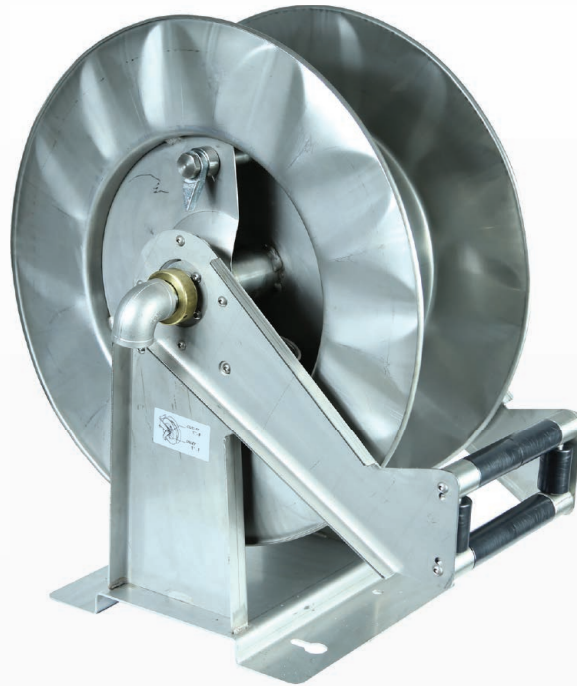

STAINLESS STEEL



MULTI POSITION

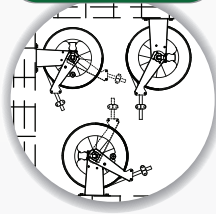

UP TO
25
mt

HOSE
PU 10x14,5
20
bar

AUTOMATIC
RETURN
HOSE

DEVICE
HOSE
GUIDE

DEVICE
HOSE
BUMPER

DEVICE
HOSE
STOP

DIMENSION
(mm)

LARGE A

LARGE B

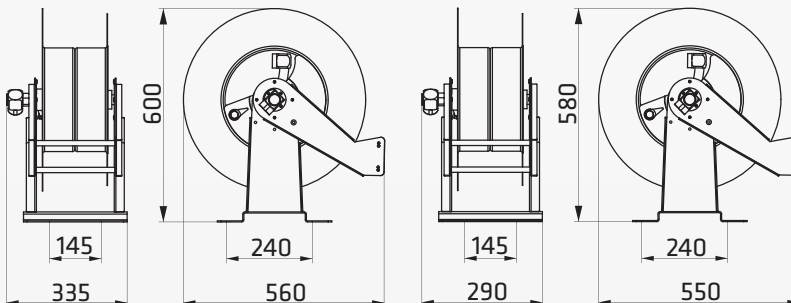

REVOLVING BRACKET

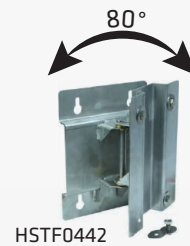

HSTF0442

name	hose including		hose max		bar max	IN	OUT	weight		packing		code	
	mt	ft	mt	ft				kg	lbs	cm	inch		
LARGE A	NO		3/8"	25	82	200	3/8" F BSP	3/8" F BSP	27,5	60,6	61 x 39 x 65	24 x 15,4 x 25,6	HAVT0015
	3/8"	25	82			200	3/8" F BSP	3/8" M BSP	41,5	91,5	61 x 39 x 65	24 x 15,4 x 25,6	WAVT0679
LARGE B	NO		1/2"	20	82	200	1/2" F BSP	1/2" F BSP	33,5	73,9	61 x 35 x 61	24 x 13,8 x 24	SAVT0675
	3/8"	25	82			200	3/8" F BSP	3/8" M BSP	37,5	82,7	61 x 35 x 61	24 x 13,8 x 24	WAVT0411

TO.ME.S. AIRWATER

SINCE 1977 Made in Italy ISO 9001:2008



Gli accessori necessari per corredare gli avvolgitubo.
Tubo per acqua e aria in PU idoneo al tiraggio con protezione anti-schiacciamento. Staffa girevole in acciaio per il fissaggio al muro dell'avvolgitubo.

The accessories needed to equip the hose reel.
Hose for water and air PU suitable to traction with protection anti-crushing. Steel revolving bracket for fixing to the wall of the hose reel.

PU 10x14,5



WTUB0765
WTUB0767

ANTI-CRUSHING

HOSE STOP



RHSP0012

PU 10x14,5



WTUB0768

90° CURVE

for hose reel SMALL

for hose reel
LARGE



HSTF0442

for hose reel
MEDIUM A



HSTF0634

for hose reel
SMALL
MEDIUM A



HSTF0441

ORIENTABLE 80°



STAINLESS STEEL



ORIENTABLE 80°



PAINTED STEEL



name	hose	length mt	made in	bar max	connection	code
HOSE	10x14,5	10	PU	20	3/8 M BSP	WTUB0765
	10x14,5	15	PU	20	3/8 M BSP	WTUB0767
HOSE for hose reel	10x14,5	10	PU	20	3/8 M BSP 3/8 F BSP 90°	WTUB0768
HOSE STOP						RHSP0012
REVOLVING BRACKET						HSTF0441
						HSTF0442
						HSTF0634